

Data sheet | Item number: 2091-1523/002-000

1-conductor male connector; Push-in CAGE CLAMP®; 1.5 mm²; Pin spacing 3.5 mm; 3-pole; Integrated release lever; 1,50 mm²; light gray

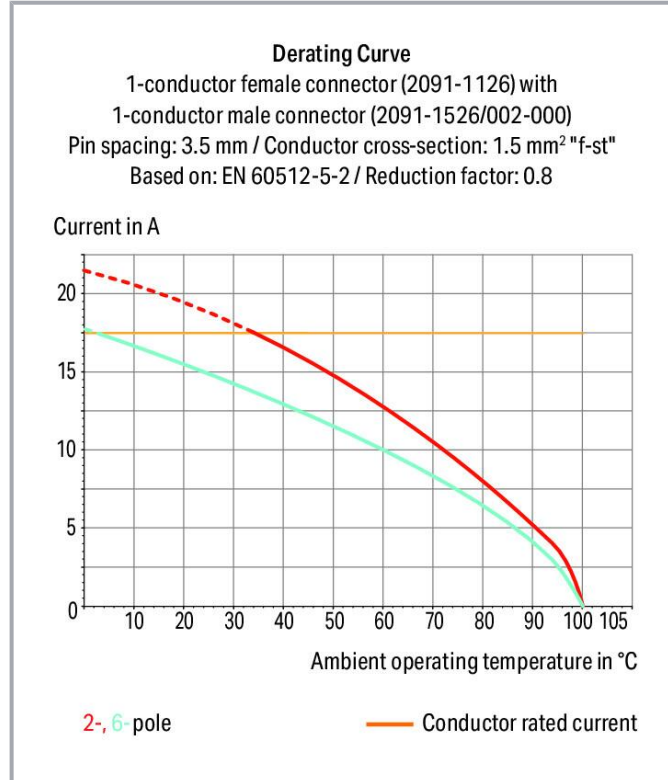

www.wago.com/2091-1523/002-000

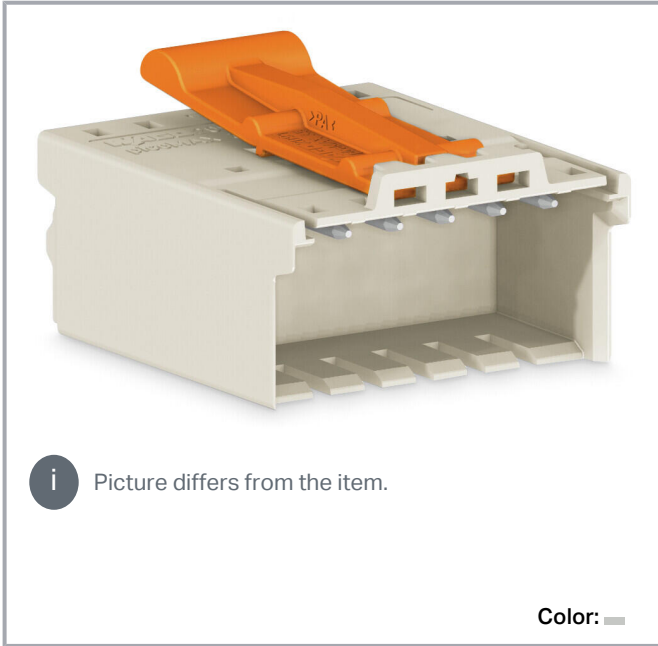

Subject to changes. Please also observe the further product documentation!

WAGO GmbH & Co. KG
Hansastr. 27
32423 Minden
Phone: +49571 887-0 | Fax: +49571 887-169
Email: info.de@wago.com | Web: www.wago.com

Do you have any questions about our products?
We are always happy to take your call at +49 (571) 887-44222.

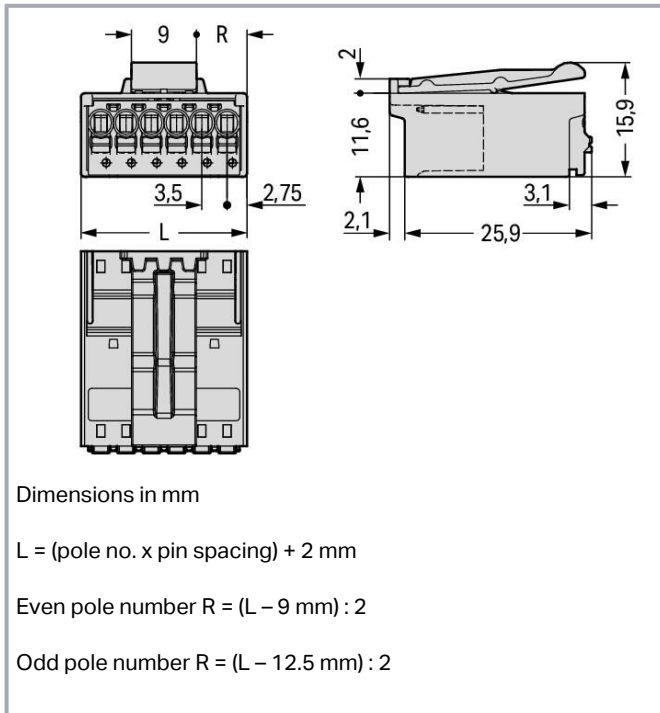

Item description

- Universal connection for all conductor types
- Simple, push-in termination of solid and ferruled conductors
- Easy-to-use design does not require special tools
- Testing parallel to conductor entry – tip contact
- For “wire-to-wire” and “board-to-wire” connections
- Integrated release lever

Data

Notes

Safety information

The **picoMAX® Pluggable Connection System** includes connectors without breaking capacity in accordance with DIN EN 61984. When used as intended, these connectors must not be connected /disconnected when live or under load. The circuit design should ensure header pins, which can be touched, are not live when unmated.

Variants:

Direct marking

Other versions (or variants) can be requested from WAGO Sales or configured at <https://configurator.wago.com/>.

Subject to changes. Please also observe the further product documentation!

WAGO GmbH & Co. KG

Hansastr. 27

32423 Minden

Phone: +49571 887-0 | Fax: +49571 887-169

Email: info.de@wago.com | Web: www.wago.com

Do you have any questions about our products?

We are always happy to take your call at +49 (571) 887-44222.

Electrical data

Ratings per IEC/EN

| Ratings per | IEC/EN 60664-1 |
|-------------------------------|---|
| Nominal voltage (III/3) | 160 V |
| Rated impulse voltage (III/3) | 2.5 kV |
| Rated voltage (III/2) | 160 V |
| Rated impulse voltage (III/2) | 2.5 kV |
| Nominal voltage (II/2) | 320 V |
| Rated surge voltage (II/2) | 2.5 kV |
| Rated current | 10 A |
| Legend (ratings) | (III / 2) $\hat{=}$ Overvoltage category III / Pollution degree 2 |

Ratings per UL 1059

| Approvals per | UL 1059 |
|--------------------------------|---------|
| Rated voltage UL (Use Group B) | 300 V |
| Rated current UL (Use Group B) | 10 A |
| Rated voltage UL (Use Group D) | 300 V |
| Rated current UL (Use Group D) | 10 A |

Connection data

| | |
|----------------------------|---|
| Connection points | 3 |
| Total number of potentials | 3 |
| Number of connection types | 1 |
| Number of levels | 1 |

Connection 1

| | |
|---|---|
| Connection technology | Push-in CAGE CLAMP® |
| Actuation type | Push-button |
| Actuation direction 1 | Operation parallel to conductor entry |
| Solid conductor | 0.2 ... 1.5 mm ² / 24 ... 14 AWG |
| Fine-stranded conductor | 0.2 ... 1.5 mm ² / 24 ... 14 AWG |
| Fine-stranded conductor; with insulated ferrule | 0.25 ... 0.75 mm ² |
| Fine-stranded conductor; with uninsulated ferrule | 0.25 ... 1.5 mm ² |
| Strip length | 8 ... 9 mm / 0.31 ... 0.35 inches |
| Pole number | 3 |

Subject to changes. Please also observe the further product documentation!



Physical data

| | |
|-------------|------------------------|
| Pin spacing | 3.5 mm / 0.138 inches |
| Width | 12.5 mm / 0.492 inches |
| Height | 15.9 mm / 0.626 inches |
| Depth | 28 mm / 1.102 inches |

Mechanical Data

| | |
|--------------------------|-----|
| Variable coding | Yes |
| Anti-rotation protection | Yes |

Plug-in connection

| | |
|--------------------------------------|---------------------|
| Contact type (pluggable connector) | Male connector/plug |
| Connector (connection type) | for conductor |
| Mismating protection | No |
| Plugging without loss of pin spacing | Yes |
| Locking of plug-in connection | Locking latch |

Material Data

| | |
|-----------------------------|--|
| Note (material data) | Information on material specifications can be found here |
| Color | light gray |
| Material group | I |
| Insulation material | Polyphthalamide (PPA GF) |
| Flammability class per UL94 | V0 |
| Clamping spring material | Chrome-nickel spring steel (CrNi) |
| Contact material | Electrolytic copper (E _{Cu}) |
| Contact plating | Tin |
| Fire load | 0.019 MJ |
| Weight | 3.6 g |

Environmental requirements

| | |
|-------------------------|-----------------|
| Limit temperature range | -60 ... +100 °C |
| Processing temperature | -35 ... +60 °C |

Subject to changes. Please also observe the further product documentation!

WAGO GmbH & Co. KG
 Hansastr. 27
 32423 Minden
 Phone: +49571 887-0 | Fax: +49571 887-169
 Email: info.de@wago.com | Web: www.wago.com

Do you have any questions about our products?
 We are always happy to take your call at +49 (571) 887-44222.

Commercial data





| | |
|-----------------------|---------------|
| eCl@ss 10.0 | 27-14-11-06 |
| eCl@ss 9.0 | 27-14-11-06 |
| ETIM 8.0 | EC001284 |
| ETIM 7.0 | EC001284 |
| PU (SPU) | 200 pcs |
| Packaging type | box |
| Country of origin | DE |
| GTIN | 4055143543477 |
| Customs tariff number | 85366990990 |

Environmental Product Compliance

| | |
|------------------------|-------------------------|
| RoHS Compliance Status | Compliant, No Exemption |
|------------------------|-------------------------|





Approvals / Certificates

General approvals

| Logo | Approval | Additional Approval Text | Certificate name |
|--|---------------------------------------|--------------------------|------------------------|
| | CB DEKRA Certification B.V. | IEC 61984 | NL-49736 /A1 |
|  | CSA DEKRA Certification B.V. | C22.2 No. 158 | 2362521 |
|  | CSA DEKRA Certification B.V. | C22.2 | 2362521 |
|  | KEMA/KEUR DEKRA Certification B.V. | EN 61984 | 71- 102260 REV.1 |
|  | UL Underwriters Laboratories Inc. | UL 1977 | E45171 |

Subject to changes. Please also observe the further product documentation!

Counterpart

| | | |
|--|--|--|
|  | Item no.2091-1123 1-conductor female connector; push-button; Push-in CAGE CLAMP®; 1.5 mm ² ; Pin spacing 3.5 mm; 3-pole; 1,50 mm ² ; light gray | www.wago.com/2091-1123 |
|  | Item no.2091-1103 1-conductor female connector; push-button; Push-in CAGE CLAMP®; 1.5 mm ² ; Pin spacing 3.5 mm; 3-pole; Gripping plate; 1,50 mm ² ; light gray | www.wago.com/2091-1103 |
|  | Item no.2091-1103/000-1000 1-conductor female connector; push-button; Push-in CAGE CLAMP®; 1.5 mm ² ; Pin spacing 3.5 mm; 3-pole; Gripping plate; direct marking; 1,50 mm ² ; light gray | www.wago.com/2091-1103/000-1000 |
|  | Item no.2091-1103/000-5000 1-conductor female connector; push-button; Push-in CAGE CLAMP®; 1.5 mm ² ; Pin spacing 3.5 mm; 3-pole; Gripping plate; direct marking; 1,50 mm ² ; light gray | www.wago.com/2091-1103/000-5000 |

Optional accessories

| | | |
|---|---|--|
| Coding | | |
| Coding | | |
|  | Item no.: 2091-1610 Coding key carrier; suitable for 3.5 mm pin spacing; orange | www.wago.com/2091-1610 |

Downloads

Documentation

Additional Information

| | | | |
|------------------------|------------|--------|----------|
| Technical Section | 2019 Apr 3 | pdf | Download |
| Technical explanations | | 2.0 MB | |

CAD/CAE-Data

CAD data

| | | |
|--------------------------------|-----|----------|
| 2D/3D Models 2091-1523/002-000 | URL | Download |
|--------------------------------|-----|----------|

CAE data

| | | |
|--------------------------------|-----|----------|
| ZUKEN Portal 2091-1523/002-000 | URL | Download |
|--------------------------------|-----|----------|

Subject to changes. Please also observe the further product documentation!



Environmental Product Compliance

Compliance Search

Environmental Product Compliance 2091-1523/002-000

URL

Download

1-conductor male connector; Push-in CAGE CLAMP®; 1.5 mm²; Pin spacing 3.5 mm;

3-pole; Integrated release lever; 1,50 mm²; light gray

Installation Notes

Subject to changes. Please also observe the further product documentation!

WAGO GmbH & Co. KG

Hansastr. 27

32423 Minden

Phone: +49571 887-0 | Fax: +49571 887-169

Email: info.de@wago.com | Web: www.wago.com

Do you have any questions about our products?

We are always happy to take your call at +49 (571) 887-44222.